

With a broad range of fittings, brackets and special accessories, the application options for Stabilus IndustryLine gas springs can be combined and extended in every possible way:

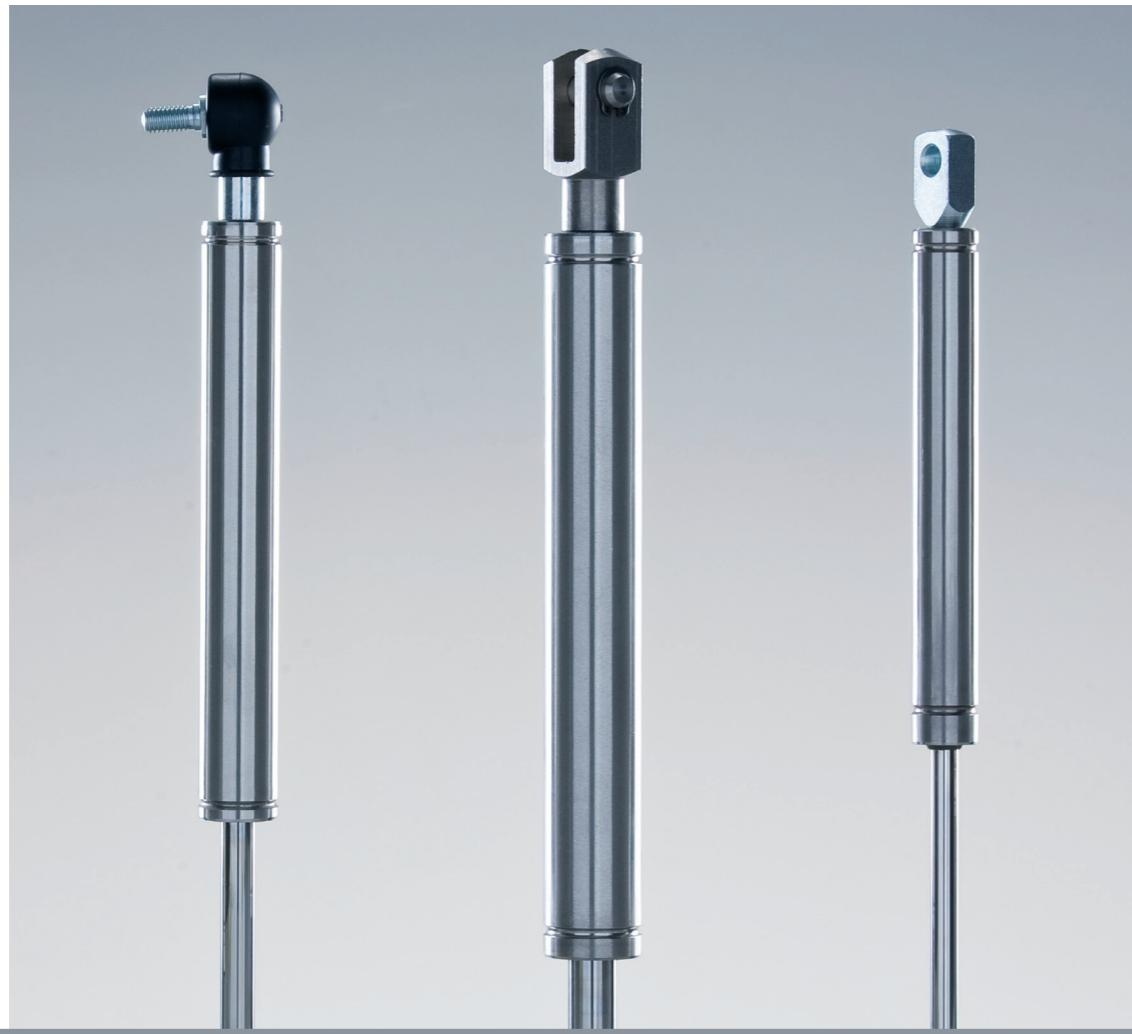

Various fittings such as fork heads, hinged eyelets, hinged joints etc. are suitable for all mounting applications in combination with the matching brackets for the product. Depending on the individual case, Stabilus IndustryLine supplies a variety of different fittings so that customers can select the best solutions from this intelligent modular system.

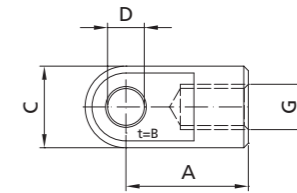

**Eyelets**

Type	Thread (G)	Installation length (A)	Thickness (B)	Width (C)	Cross hole Ø (D)	Steel	AISI 303/304	AISI 316L/316Ti	Plastic
AU08	M2	8 mm	2,5 mm	4 mm	2.1 mm	•	–	–	–
AU11	M3.5	11 mm	4 mm	8 mm	4.1 mm	•	–	–	–
AS20	M5	20 mm	3 mm	12 mm	6.1 mm	•	•	–	–
AU16	M5	16 mm	6 mm	10 mm	6.1 mm	•	•	•	–
AR16	M5	16 mm	10 mm	15 mm	8.1 mm	•	–	–	–
AK17	M8	17 mm	14 mm	14 mm	8.1 mm	–	–	–	•
AK21	M8	21 mm	18 mm	18 mm	8.1 mm	–	–	–	•
AR16	M8	16 mm	10 mm	15 mm	8.1 mm	•	–	–	–
AR19	M8	19 mm	10 mm	15 mm	8.1 mm	•	–	–	–
AR19	M8	19 mm	10 mm	15 mm	10.1 mm	•	–	–	–
AR27	M8	27 mm	10 mm	15 mm	8.1 mm	•	–	–	–
AS19	M8	19 mm	8 mm	14 mm	8.1 mm	•	–	–	–
AS24	M8	24 mm	6 mm	14 mm	8.1 mm	•	–	–	–
AS30	M8	30 mm	5 mm	18 mm	8.1 mm	•	–	–	–
AU19	M8	19 mm	10 mm	14 mm	8.1 mm	•	•	•	–
AU19	M8	19 mm	10 mm	14 mm	6.1 mm	•	–	–	–
AK21	M10	21 mm	18 mm	18 mm	8.1 mm	–	–	–	•
AS27	M10	27 mm	14 mm	18 mm	8.1 mm	•	–	–	–
AU27	M10	27 mm	10 mm	18 mm	8.1 mm	•	•	•	–
AU27	M10	27 mm	10 mm	18 mm	10.1 mm	•	•	•	–
AU42	M14x1.5	42 mm	14 mm	25 mm	14.1 mm	•	•	•	–

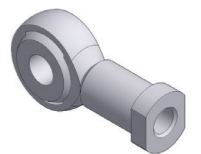
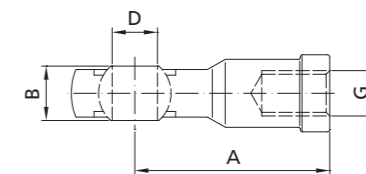

**Hinged joints**

Type	Thread (G)	Installation length (A)	Thickness (B)	Width	Cross hole Ø (D)	Steel	AISI 303/304	AISI 316L/316Ti	Plastic
AG12	M2	12.5 mm	4 mm	–	2 mm	–	–	–	•
AG27	M5	27 mm	8 mm	9 mm	5 mm	•	•	o/r	–
AG36	M8	36 mm	12 mm	13 mm	8 mm	•	•	o/r	–
AG43	M10	43 mm	14 mm	17 mm	10 mm	•	•	o/r	–
AG57	M14x1.5	57 mm	19 mm	22 mm	14 mm	•	•	o/r	–

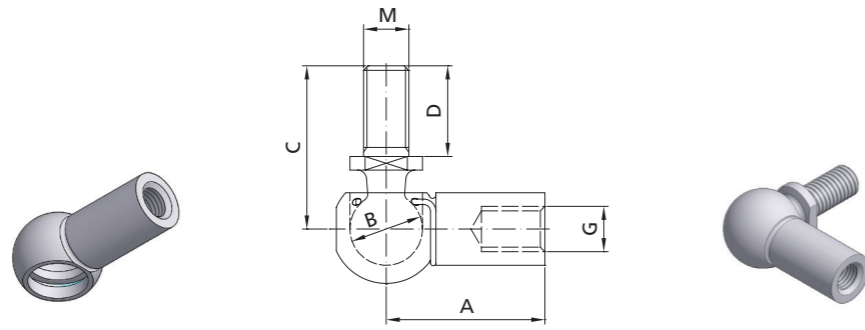

**Ball joints and sockets**

Type	Thread (G)	Installation length (A)	Socket diameter (B)	Bolt length (C)	Thread (MxD)	Steel	AISI 303/304	AISI 316L/316Ti
PF 12	M2	12.5 mm	4 mm	12.5 mm	-	•	-	-
WG 12	M2	12.5 mm	4 mm	12.5 mm	M2x7.5	•	-	-
PX 18	M3.5	18 mm	8 mm	-	-	•	-	-
WX 18	M3.5	18 mm	8 mm	19 mm	M4x10	•	-	-
PF 22	M5	22 mm	8 mm	-	-	•	o/r	o/r
PX 22	M5	22 mm	10 mm	-	-	•	-	-
WD 22	M5	22 mm	10 mm	19 mm	M8x12	•	-	-
WG 22	M5	22 mm	8 mm	19 mm	M5x10	•	•	•
WX 22	M5	22 mm	10 mm	23 mm	M8x12	•	•	-
WY 22	M5	22 mm	10 mm	23 mm	M6x12	•	-	-
PF 18	M8	18 mm	10 mm	-	-	•	-	-
PF 30	M8	30 mm	13 mm	-	-	•	o/r	o/r
WD 30	M8	30 mm	13 mm	29 mm	M8x16	•	-	-
WG 18	M8	18 mm	10 mm	23 mm	M8x12	•	•	-
WG 30	M8	30 mm	13 mm	29 mm	M8x16	•	•	•
WS 35	M8	35 mm	16 mm	36 mm	M10x20	•	-	-
WX 30	M8	30 mm	13 mm	29 mm	M10x16	•	-	-
PF 35	M10	35 mm	16 mm	-	-	•	-	-
WG 35	M10	35 mm	16 mm	36 mm	M10x20	•	•	•
WG 45	M14x1.5	45 mm	19 mm	48 mm	M14x28	•	•	•

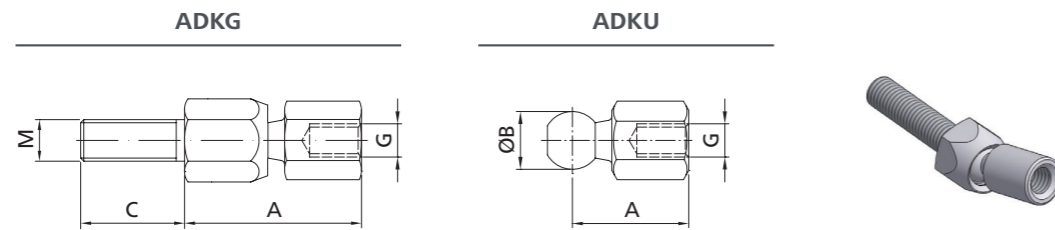

**Axial joints**

Type	Thread (G)	Installation length (A)	Ball diameter (B)	Bolt (MxC)	Steel	AISI 303/304	AISI 316L/316Ti
ADKG	M5	28 mm	8 mm	M8x35	•	-	-
ADKU	M5	20 mm	8 mm	-	•	-	-
ADKG	M8	31 mm	10 mm	M8x35	•	-	o/r
ADKU	M8	23 mm	10 mm	-	•	-	-
ADKG	M10	43 mm	14 mm	M10x25	•	-	o/r
ADKU	M10	28 mm	14 mm	-	•	-	-
ADKG	M14x1.5	56 mm	20 mm	M14x1.5x40	•	-	-
ADKU	M14x1.5	35 mm	20 mm	-	•	-	-

**Base plate eyelet (for tube side)**

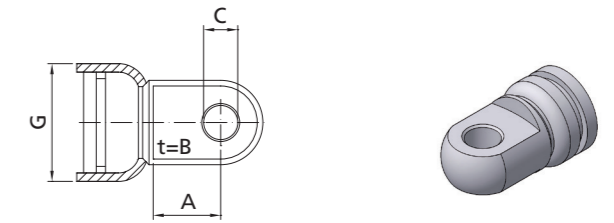

Type	For cylinder Ø (G)	Installation length (A)	Thickness (B)	Cross hole Ø (C)	Steel	AISI 303/304	AISI 316L/316Ti
AB 04	6 mm	4 mm	2.5 mm	2.1 mm	•	-	-
AB 07	10 mm	7 mm	4 mm	4.1 mm	•	-	-
AB 07	12 mm	7 mm	4 mm	4.1 mm	•	-	-
AB 09	15 mm	9 mm	6 mm	6.1 mm	•	-	-
AB 11	19 mm	11 mm	10 mm	6.1 mm	•	-	-
AB 11	19 mm	11 mm	10 mm	8.1 mm	•	-	-
AB 11	23 mm	11 mm	10 mm	8.1 mm	•	-	-
AB 11	23 mm	11 mm	10 mm	10.1 mm	•	-	-
AB 16	28 mm	16 mm	10 mm	8.1 mm	•	-	-
AB 16	28 mm	16 mm	10 mm	10.1 mm	•	-	-
AZ 20	40 mm	20 mm	14 mm	14.1 mm	•	•	-

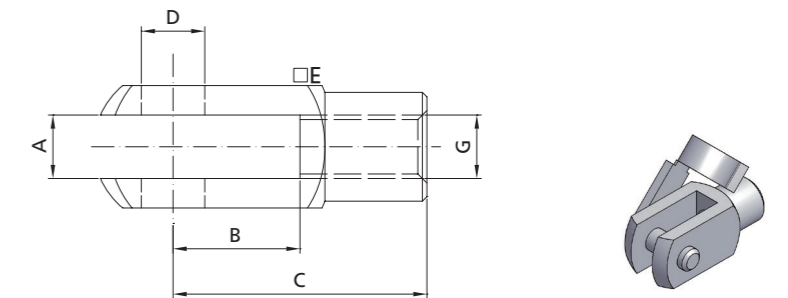

**Forks**

Type	Thread (G)	Size (A x B)	Installation length (C)	Width (E)	Bolt Ø (D)	Steel	AISI 303/304	AISI 316L/316Ti
GA 16	M3.5	4x8 mm	16 mm	8 mm	4 mm	•	-	-
GG 16*	M3.5	4x8 mm	16 mm	8 mm	4 mm	•	-	-
GA 20	M5	5x10 mm	20 mm	10 mm	5 mm	•	•	-
GG 20*	M5	5x10 mm	20 mm	10 mm	5 mm	•	•	•
GA 32	M8	8x16 mm	32 mm	16 mm	8 mm	•	•	-
GG 32*	M8	8x16 mm	32 mm	16 mm	8 mm	•	•	•
GS 40	M8	10x20 mm	40 mm	20 mm	10 mm	•	-	-
GA 40	M10	10x20 mm	40 mm	20 mm	10 mm	•	•	-
GG 40*	M10	10x20 mm	40 mm	20 mm	10 mm	•	•	•
GS 32	M10	8x16 mm	32 mm	16 mm	8 mm	•	-	-
GX 32	M10x1	8x16 mm	32 mm	16 mm	8 mm	•	-	-
GA 56	M14x1.5	14x28 mm	56 mm	27 mm	14 mm	•	•	-
GG 56*	M14x1.5	14x28 mm	56 mm	27 mm	14 mm	•	•	•
GA 80	M20	20x40 mm	80 mm	40 mm	20 mm	•	-	-
GA 99	M24	25x50 mm	99 mm	50 mm	25 mm	•	-	-

\* Fork joint steel with ES-bolts, AISI 303/304 with Ben bolts, AISI 316L/316Ti with eyebolts.